

Spezifikation für Freigabe / specification for release

Kunde / customer :
 Artikelnummer / part number : **7447797360**
 Bezeichnung : **SPEICHERDROSSEL WE-PDF**
 description : **POWER-CHOKE WE-PDF**



DATUM / DATE : 2011-08-30

A Mechanische Abmessungen / dimensions :

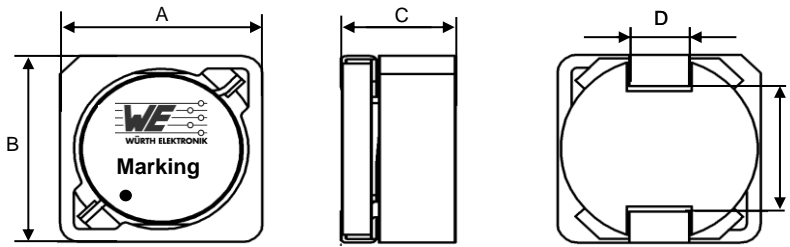

● Start of winding

Marking = Inductance code

| | size 1045 | |
|---|------------|----|
| A | 10,2 ± 0,3 | mm |
| B | 10,2 ± 0,3 | mm |
| C | 4,5 max. | mm |
| D | 3,0 ± 0,2 | mm |
| E | 6,8 ± 0,5 | mm |

B Elektrische Eigenschaften / electrical properties :

| Eigenschaften / properties | Testbedingungen / test conditions | | Wert / value | Einheit / unit | tol. |
|--|-----------------------------------|---------------------|--------------|----------------|------|
| Induktivität / inductance | 100 kHz / 0,25V | L | 3,60 | µH | ±20% |
| DC-Widerstand / DC-resistance | @ 20°C | R _{DC typ} | 10,8 | mΩ | typ. |
| DC-Widerstand / DC-resistance | @ 20°C | R _{DC max} | 12,2 | mΩ | max. |
| Nennstrom / rated current | ΔT=40 K | I _R | 8,20 | A | max. |
| Sättigungsstrom / saturation current | ΔL/L <10% | I _{sat} | 8,50 | A | typ. |
| Eigenres.-Frequenz / self-res.-frequency | | f _{res} | 55,0 | MHz | typ. |

C Lötpad / soldering spec. :

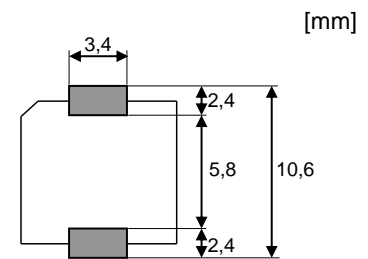

D Prüfgeräte / test equipment :

Wayne Kerr 3260B für/for L und/and I_{sat}
 GMC Metrahit für/for R_{DC}
 Agilent N5776A für/for I_R
 Agilent E4991A für/for f_{res}

E Testbedingungen / test conditions :

Luftfeuchtigkeit / humidity: 33%
 Umgebungstemperatur / temperature: +20°C

F Werkstoffe & Zulassungen / material & approvals :

Basismaterial / base material: Ferrit/ferrite
 Endoberfläche / finishing electrode: Sn / Ni
 Draht / wire: SFT-EI / AIWJ
 UL-File Number: E318511

G Eigenschaften / general specifications :

Betriebstemp. / operating temperature: -40°C - +150°C
 Umgebungstemp. / ambient temperature: -40°C - +110°C
 It is recommended that the temperature of the part does not exceed 150°C under worst case operating conditions.

| | | | |
|-------------------------------------|--------------------------|-------------------------|--------------|
| Freigabe erteilt / general release: | Kunde / customer | | |
| | | | |
| Datum / date | Unterschrift / signature | | |
| | | | |
| Geprüft / checked | Würth Elektronik | | |
| | SvS | Version3 | 11-08-30 |
| | OO | Version 2 | 09-07-06 |
| | OO | Version 1 | 08-06-01 |
| Kontrolliert / approved | Name | Änderung / modification | Datum / date |

Würth Elektronik eiSos GmbH & Co.KG

D-74638 Waldenburg · Max-Eyth-Straße 1 - 3 · Germany · Telefon (+49) (0) 7942 - 945 - 0 · Telefax (+49) (0) 7942 - 945 - 400
<http://www.we-online.com>

Spezifikation für Freigabe / specification for release

Kunde / customer : _____
 Artikelnummer / part number : **7447797360**
 Bezeichnung : **SPEICHERDROSSEL WE-PDF**
 description : **POWER-CHOKE WE-PDF**



DATUM / DATE : 2011-08-30

H Induktivitätskurve / Inductance curve :

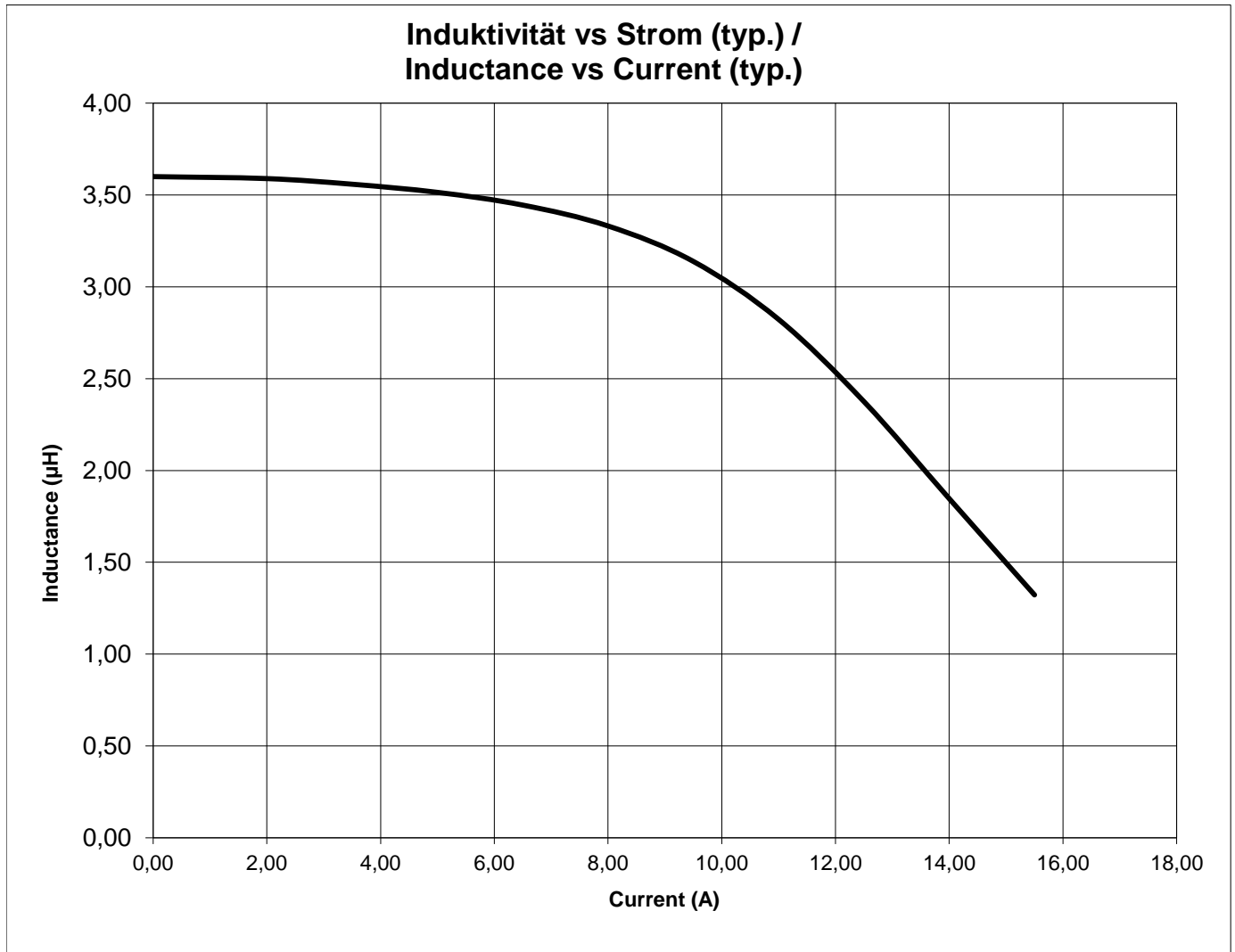

| | | | | |
|-------------------------------------|-------------------------|------|-------------------------|--------------|
| Freigabe erteilt / general release: | Kunde / customer | | | |
| | | | | |
| Datum / date | Würth Elektronik | SVS | Version3 | 11-08-30 |
| | | OO | Version 2 | 09-07-06 |
| Geprüft / checked | Kontrolliert / approved | OO | Version 1 | 08-06-01 |
| | | Name | Änderung / modification | Datum / date |

Würth Elektronik eiSos GmbH & Co.KG

D-74638 Waldenburg · Max-Eyth-Straße 1 - 3 · Germany · Telefon (+49) (0) 7942 - 945 - 0 · Telefax (+49) (0) 7942 - 945 - 400
<http://www.we-online.com>

Spezifikation für Freigabe / specification for release

Kunde / customer : _____
 Artikelnummer / part number : **7447797360**
 Bezeichnung : **SPEICHERDROSSEL WE-PDF**
 description : **POWER-CHOKE WE-PDF**



DATUM / DATE : 2011-08-30

I Induktivitäts-Temperatur-Kurve / Inductance Temperature curve :

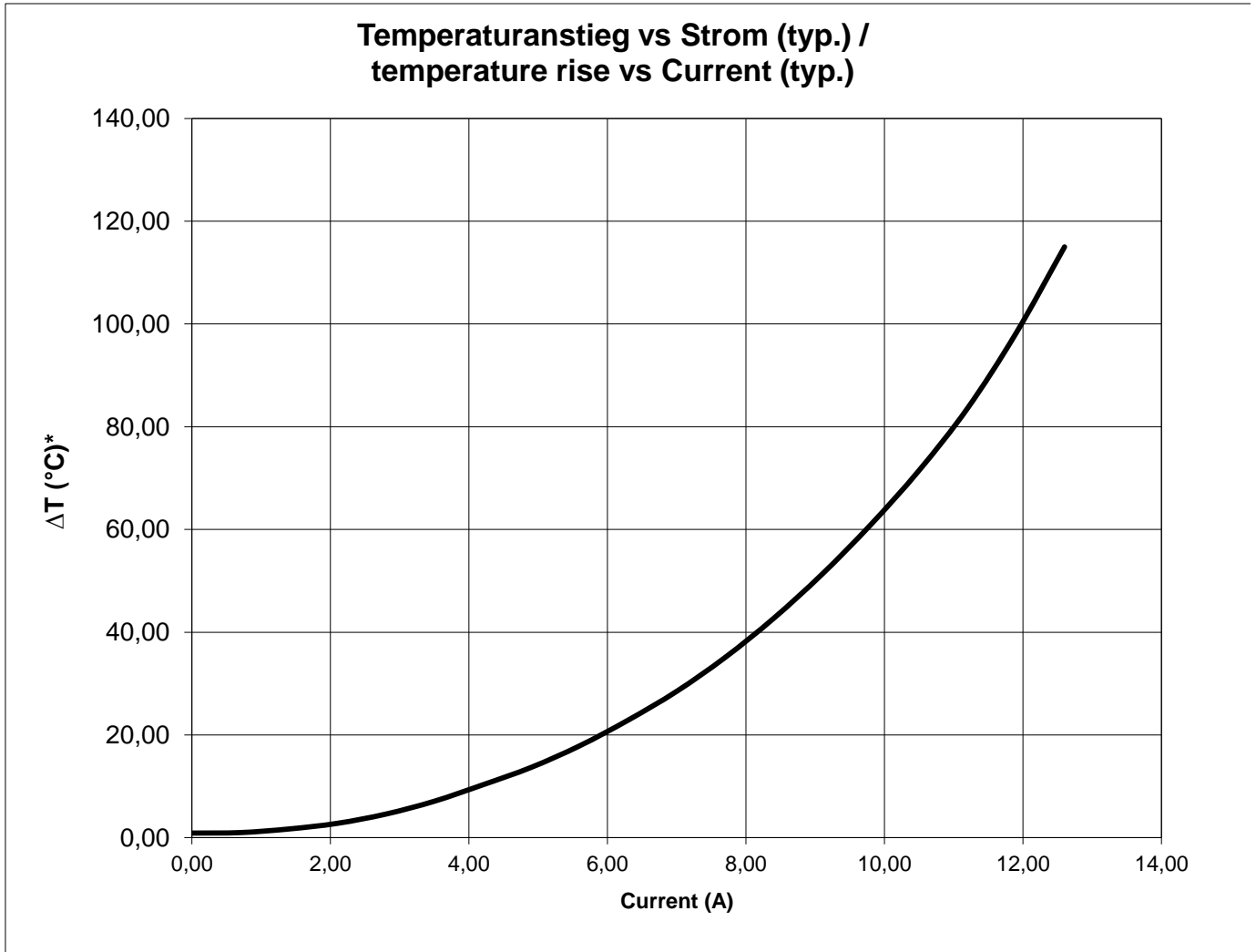

*Temperatur gemessen an Bauteiloberfläche / temperature measured at surface of component

| | | | | |
|-------------------------------------|--------------------------|------|--------------------------------|--------------|
| Freigabe erteilt / general release: | Kunde / customer | | | |
| | | | | |
| Datum / date | Unterschrift / signature | | | |
| | Würth Elektronik | SvS | Version3 | 11-08-30 |
| | | OO | Version 2 | 09-07-06 |
| | | OO | Version 1 | 08-06-01 |
| | | Name | Änderung / modification | Datum / date |
| Geprüft / checked | Kontrolliert / approved | | | |

Würth Elektronik eiSos GmbH & Co.KG

D-74638 Waldenburg · Max-Eyth-Straße 1 - 3 · Germany · Telefon (+49) (0) 7942 - 945 - 0 · Telefax (+49) (0) 7942 - 945 - 400
<http://www.we-online.com>

Spezifikation für Freigabe / specification for release

Kunde / customer : _____
 Artikelnummer / part number : **7447797360**
 Bezeichnung : **SPEICHERDROSSEL WE-PDF**
 description : **POWER-CHOKE WE-PDF**



DATUM / DATE : 2011-08-30

K Rollenspezifikation / tape and reel specification :

Gurtspezifikation / Tape specification:

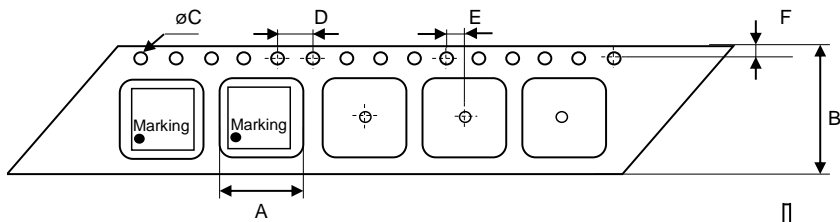

| | | |
|---|-------------|----|
| A | 10,45 ± 0,1 | mm |
| B | 24,0 ± 0,2 | mm |
| C | 1,55 ± 0,5 | mm |
| D | 4,00 ± 0,1 | mm |
| E | 2,00 ± 0,1 | mm |
| F | 1,75 ± 0,1 | mm |
| G | 10,45 ± 0,1 | mm |
| H | 5,00 ± 0,1 | mm |

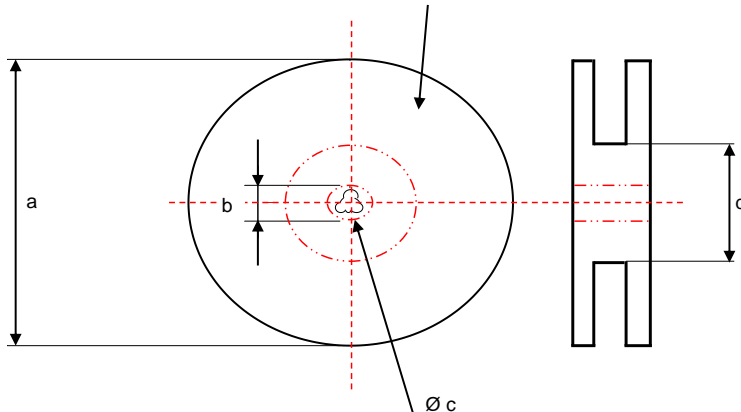
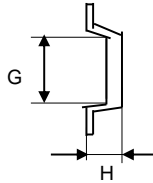

Rollenspezifikation / Reel specification:

| | | |
|---|-------------|----|
| a | 330,0 ± 2,0 | mm |
| b | 21,00 ± 0,8 | mm |
| c | 13,00 ± 0,5 | mm |
| d | 100,0 ± 1,0 | mm |

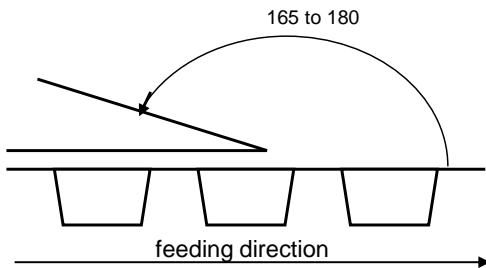

The force for tearing off cover tape is 10 to 130 grams in arrow direction

| | | | |
|-------------------------------------|--------------------------|-------------------------|--------------|
| Freigabe erteilt / general release: | Kunde / customer | | |
| | | | |
| Datum / date | Unterschrift / signature | | |
| | Würth Elektronik | | |
| Geprüft / checked | SvS | Version3 | 11-08-30 |
| | OO | Version 2 | 09-07-06 |
| | OO | Version 1 | 08-06-01 |
| | Name | Änderung / modification | Datum / date |

This electronic component has been designed and developed for usage in general electronic equipment. Before incorporating this component into any equipment where higher safety and reliability is especially required or if there is the possibility of direct damage or injury to human body, for example in the range of aerospace, aviation, nuclear control, submarine, transportation, (automotive control, train control, ship control), transportation signal, disaster prevention, medical, public information network etc, Würth Elektronik eiSos GmbH must be informed before the design-in stage. In addition, sufficient reliability evaluation checks for safety must be performed on every electronic component which is used in electrical circuits that require high safety and reliability functions or performance.

Würth Elektronik eiSos GmbH & Co.KG

D-74638 Waldenburg · Max-Eyth-Straße 1 - 3 · Germany · Telefon (+49) (0) 7942 - 945 - 0 · Telefax (+49) (0) 7942 - 945 - 400
<http://www.we-online.com>